



Statement: The products listed in this catalogue only for conference. Specifications are subject to change without notice.



SHARM LIGHT COMPANY

Is a German Chinese Syrian Company, established on 2001, in China Guangdong Province - Foshan city - Shunde District - Leliu town, on a land of 65000 square meters, with workers upto 1650 employees, that include working teams of responsible engineers about research and development.

OUR PRODUCTS:

Spot Lights Down lights-Ceiling lamps-bulbs, which are made of very high quality raw materials, such as (Pure Aluminum 100% coated by electrical system, and isolated with special products, to be anti-humidity, and have international quality certificates (CE-RoHS-UL-ISO 9001).

Besides Sharm Light Company has powerful experience in producing electrical switches and sockets with real lifetime warranty, and produced with very high international quality raw materials, such as copper coated with silver, and also pure PC which is treated and processed to be anti-flame, and holds international quality certificates.

TARGET MARKETS

Sharm Light company provides advanced solutions for saving energy for all sectors: lighting of streets – offices – hotels – homes – industrial establishments, as well as Sharm Light is the pioneer company for shaping the future through new applications and interesting technology which supplies the lighting, such as LED technology.

Sharm Lighting has the certificate CE, RoHS, UL, ISO, CIQ, SASO, SNAS, GSC, FCC, TUV, GS. So can export the products to all over the world.

تمتلك شركة شارم للإضاءة شهادات من CE, RoHS, UL, ISO, CIQ, SASO, SNAS, GSC, FCC, TUV, GS تمكنا من تصدير منتجاتنا إلى كافة أنحاء العالم.

Sharm light products covers several countries such as Egypt, Saudi Arabia, Qatar, Sudan, Syria, Palestine, Libya, Algeria, Lebanon, Iraq, Kuwait Jordan, UAE Emirates, Turkey, England, Australia, Canada, and Brazil.

On the beginning of year 2015 Sharm Light Company entered European markets starting from France through partnership relation with SAS ROYAL ECLAIRAGE French Company, to start covering all Europe continent in future.

will progress their business.

CHINA TO
Middle East
France
Spain
Turkey
Greece



CUSTOMER FOCUSED

SHARM LIGHTING EXPERIENCE(S.L.E.X)

We in Sharm Light company realize the importance of true understanding of our customer's inspirations and needs, and work to provide, and for this reason we start our work by getting as much information as possible from all segments of society that we aim them:

The priorities, values and aspirations, as well as the things that attracts them and doesn't attract them.

By using these ideas Sharm Light Company's designing team with diversified and multiple specialty engineers will be enabled to find proper solutions which ahead our customer's needs and exceeds their outlook, so as a result will progress their business .

SHARM LIGHT COMPANY

Sharm Light company is working on leadership shifting towards solutions for saving energy , as he is a pioneer in the world for production of lighting materials .

As a matter of fact 25 % of consumed electricity in Middle East is used for lighting , so by using energy saving strategy will make less rates of electricity consumption all over the world which will result to reducing emission of carbon dioxide CO2 .

Sharm Light company provides advanced solutions for saving energy for all sectors : lighting of streets – offices – hotels – homes – industrial establishments, as well as Sharm Light is the pioneer company for shaping the future through new applications and interesting technology which supplies the lighting , such as LED technology .





RECESSED
CURVE FRAME
LED
PANEL LIGHT

PRODUCT FEATURE

- Mitsubishi Acrylic Material from Japan
- Edison SMD LED chip from TaiWan
- TOP quality driver

| Model No. | SH2009-03 | SH2009-06 | SH2009-09 | SH2009-12 | SH2009-15 | SH2009-18 | SH2009-24 |
|-----------|--------------------|--------------------|--------------------|--------------------|--------------------|--------------------|--------------------|
| Power | 3W | 6W | 9W | 12W | 15W | 18W | 24W |
| Lumen | 225lm | 510lm | 765lm | 1020lm | 1275lm | 1620lm | 2160lm |
| Material | Aluminum + acrylic | Aluminum + acrylic | Aluminum + acrylic | Aluminum + acrylic | Aluminum + acrylic | Aluminum + acrylic | Aluminum + acrylic |
| Chip | Edison | Edison | Edison | Edison | Edison | Edison | Edison |
| Pcs/Ctn | 50PCS | 30PCS | 30PCS | 20PCS | 20PCS | 20PCS | 10PCS |

WW 3000~3200K/NW 4000~4200K/WH 6000~6500K Input Voltage: AC85-265V 50/60Hz

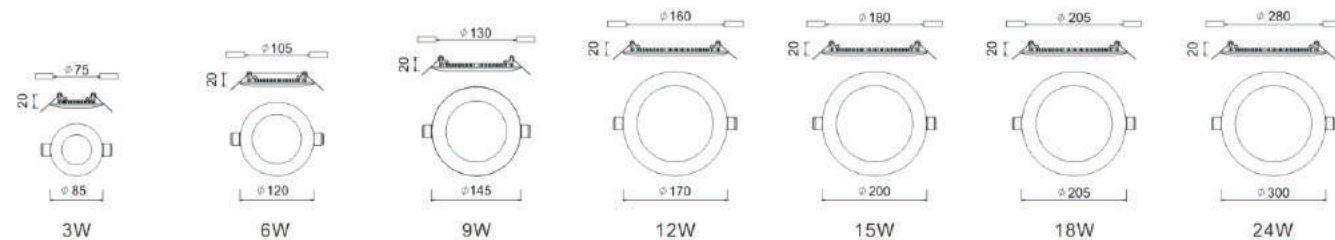

RECESSED CURVE FRAME LED PANEL LIGHT



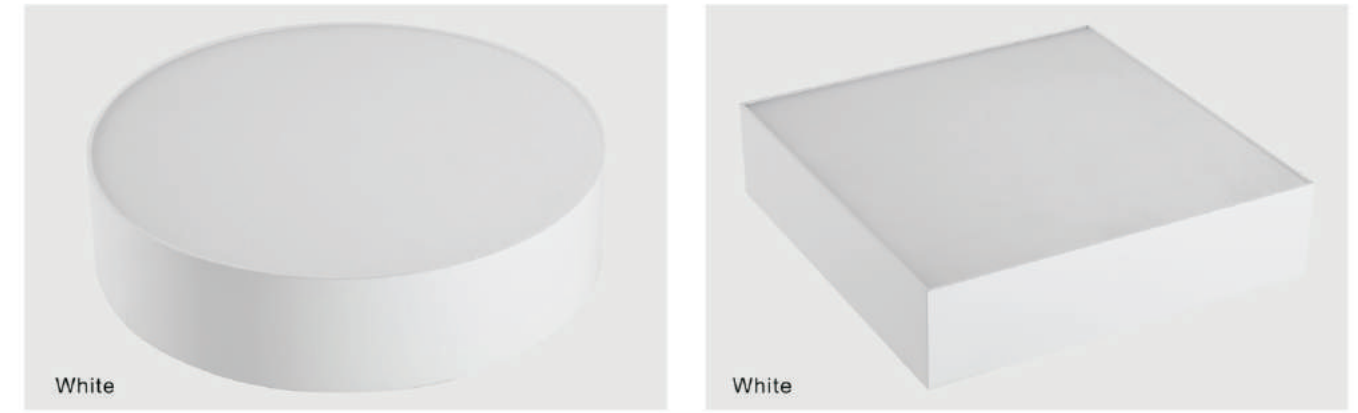

PRODUCT FEATURE

- Mitsubishi Acrylic Material from Japan
- Edison SMD LED chip from TaiWan
- TOP quality driver

| Model No. | SH26030R | SH26040R | SH24060R | SH24080R |
|-----------|------------------|------------------|------------------|------------------|
| Power | 4+2W | 6+3W | 12+4W | 18+6W |
| Lumen | 300lm | 510lm | 1020lm | 1620lm |
| Material | Aluminum+Acrylic | Aluminum+Acrylic | Aluminum+Acrylic | Aluminum+Acrylic |
| Chip | Edison | Edison | Edison | Edison |
| Pcs/Ctn | 40 | 40 | 20 | 20 |

WW 3000~3200K/NW 4000~4200K/WH 6000~6500K Input Voltage: AC85-265V 50/60Hz

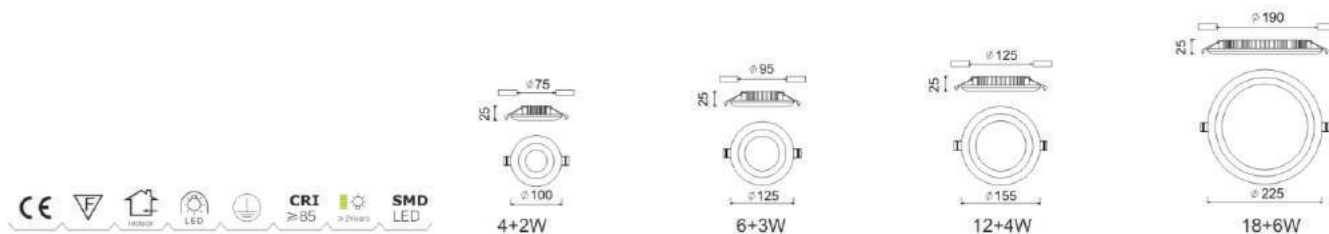

PRODUCT FEATURE

- Edison SMD LED chip from TaiWan
- TOP quality driver

| Model No. | SH41105R | SH41110R | / | SH41120R | SH41130R |
|-----------|-------------|-------------|-------------|-------------|-------------|
| Model No. | / | / | SH41115S | SH41120S | SH41130S |
| Power | 5W | 10W | 15W | 20W | 30W |
| Lumen | 375lm | 850lm | 1275lm | 1800lm | 2700lm |
| Material | Aluminum+PC | Aluminum+PC | Aluminum+PC | Aluminum+PC | Aluminum+PC |
| Chip | Edison | Edison | Edison | Edison | Edison |
| Pcs/Ctn | 40PCS | 30PCS | 20PCS | 20PCS | 10PCS |

WW 3000~3200K/NW 4000~4200K/WH 6000~6500K Input Voltage: AC85-265V 50/60Hz

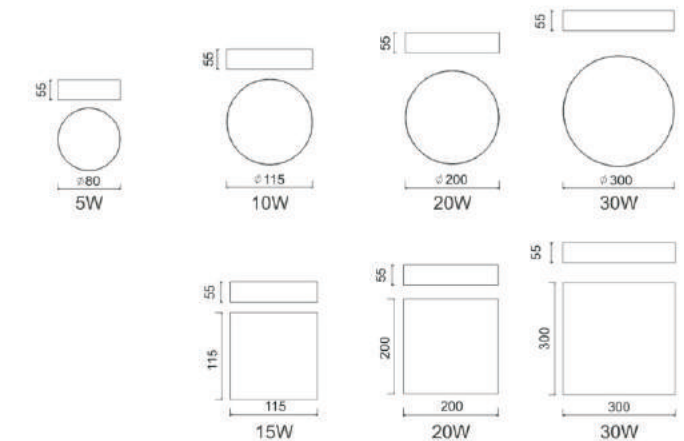



PRODUCT FEATURE

- Mitsubishi Acrylic Material from Japan
- Edison SMD LED chip from TaiWan
- TOP quality driver

| Model No. | SH2008-6W | SH2008-12W | SH2008-18W | SH2008-24W | SH2008-30W |
|-----------|------------------|------------------|------------------|------------------|------------------|
| Model No. | SH2007-6W | SH2007-12W | SH2007-18W | SH2007-24W | SH2007-30W |
| Power | 6W | 12W | 18W | 24W | 30W |
| Lumen | 510lm | 1020lm | 1620lm | 2160lm | 2700lm |
| Material | Aluminum+Acrylic | Aluminum+Acrylic | Aluminum+Acrylic | Aluminum+Acrylic | Aluminum+Acrylic |
| Chip | Edison | Edison | Edison | Edison | Edison |
| Pcs/Ctn | 40 | 20 | 10 | 10 | 10 |

WW 3000~3200K/NW 4000~4200K/WH 6000~6500K Input Voltage: AC85-265V 50/60Hz

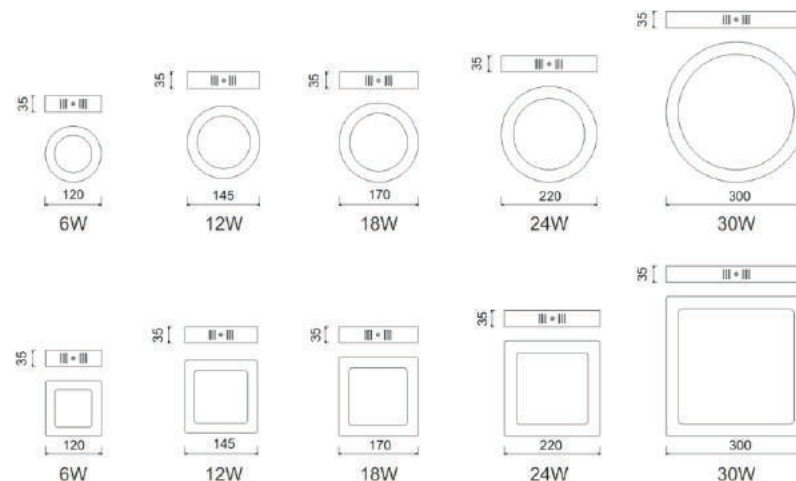

PRODUCT FEATURE

- Mitsubishi Acrylic Material from Japan
- Edison SMD LED chip from TaiWan
- TOP quality driver

| Model No. | SH4125R | SH4135R | SH4140R | SH4150R | SH4160R | SH4180R | SH41010R |
|-----------|------------------|------------------|------------------|------------------|------------------|------------------|------------------|
| Power | 3W | 6W | 9W | 12W | 15W | 18W | 24W |
| Lumen | 225lm | 510lm | 765lm | 1020lm | 1275lm | 1620lm | 2160m |
| Material | Aluminum+Acrylic | Aluminum+Acrylic | Aluminum+Acrylic | Aluminum+Acrylic | Aluminum+Acrylic | Aluminum+Acrylic | Aluminum+Acrylic |
| Chip | Edison | Edison | Edison | Edison | Edison | Edison | Edison |
| Pcs/Ctn | 50 | 40 | 40 | 20 | 20 | 20 | 10 |

PRODUCT FEATURE

- Mitsubishi Acrylic Material from Japan
- Edison SMD LED chip from TaiWan
- TOP quality driver

| Model No. | SH3030G | SH3060G | SH6060G | SH30120G |
|-----------|------------------|------------------|------------------|------------------|
| Power | 12W | 24W | 36W/48W | 48W |
| Lumen | 1020lm | 2160lm | 3240lm/4320lm | 4320lm |
| Material | Aluminum+Acrylic | Aluminum+Acrylic | Aluminum+Acrylic | Aluminum+Acrylic |
| Chip | Edison | Edison | Edison | Edison |
| Pcs/Ctn | 20 | 10 | 5 | 5 |

WW 3000~3200K/NW 4000~4200K/WH 6000~6500K Input Voltage: AC85-265V 50/60Hz

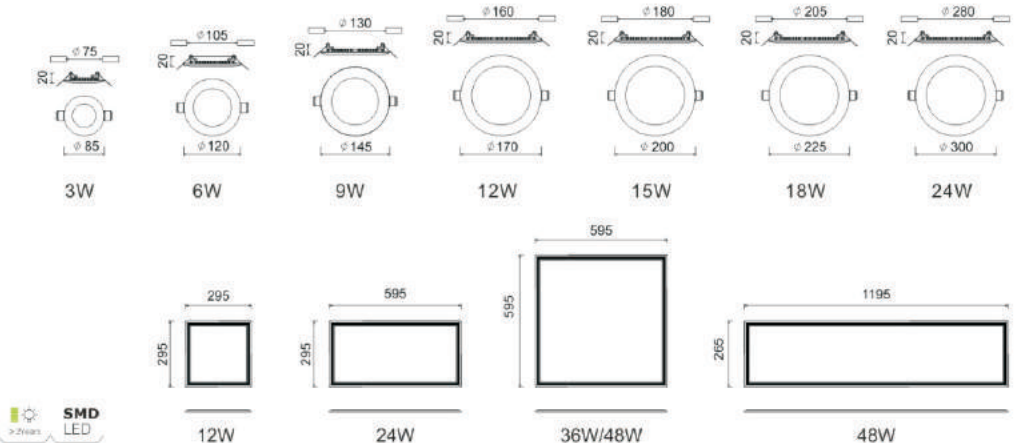

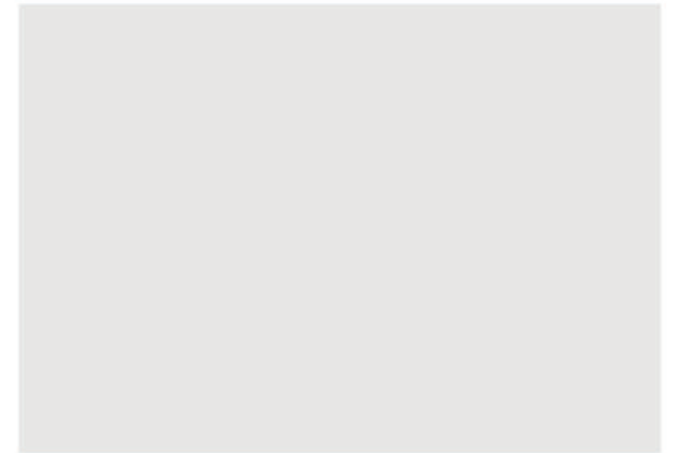

PRODUCT FEATURE

- Bridgelux COB Chip from America
- TOP quality driver

| Model No. | SH1113 | SH1114 | SH1115 | SH1117 |
|-----------|------------------|------------------|------------------|------------------|
| Power | 3W | 3W | 3W | 3W |
| Lumen | 225lm | 225lm | 225lm | 225lm |
| Material | Aluminum+Acrylic | Aluminum+Acrylic | Aluminum+Acrylic | Aluminum+Acrylic |
| Chip | Bridgelux | Bridgelux | Bridgelux | Bridgelux |
| Pcs/Ctn | 100 | 100 | 100 | 100 |

WW 3000~3200K/NW 4000~4200K/WH 6000~6500K Input Voltage: AC85-265V 50/60Hz

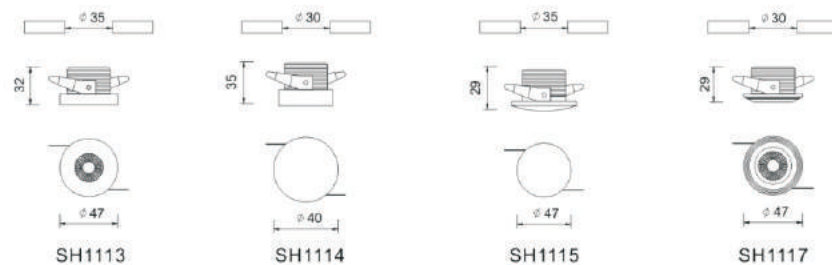

PRODUCT FEATURE

- Bridgelux COB Chip from America
- TOP quality driver

| Model No. | SH1118 | SH1119 | SH1120 |
|-----------|------------------|------------------|------------------|
| Power | 3W | 3W | 3W |
| Lumen | 225lm | 225lm | 225lm |
| Material | Aluminum+Acrylic | Aluminum+Acrylic | Aluminum+Acrylic |
| Chip | Bridgelux | Bridgelux | Bridgelux |
| Pcs/Ctn | 100 | 100 | 100 |

WW 3000~3200K/NW 4000~4200K/WH 6000~6500K Input Voltage: AC85-265V 50/60Hz

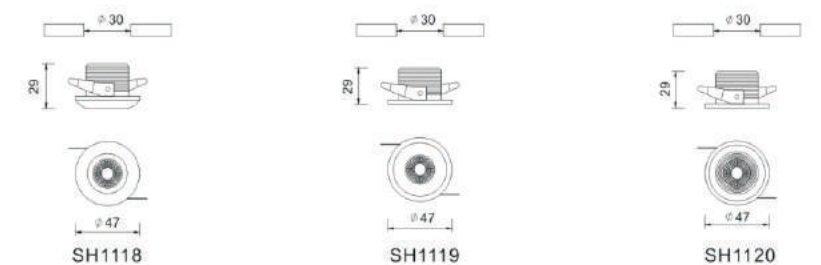

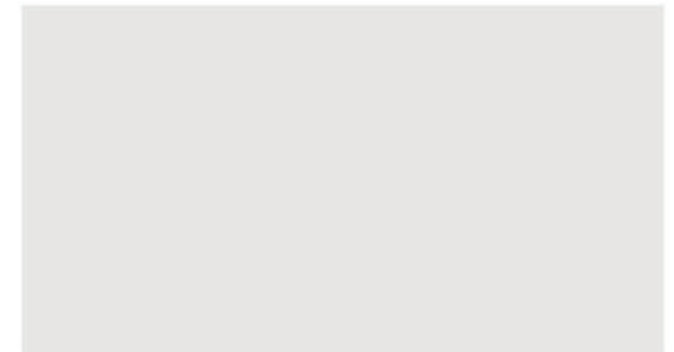

PRODUCT FEATURE

- Bridgelux COB Chip from America
- TOP quality driver

| | |
|-----------|----------------|
| Model No. | SH2705 |
| Power | 5W |
| Lumen | 375lm |
| Material | Aluminum+glass |
| Chip | Bridgelux |
| Pcs/Ctn | 100 |

WW 3000~3200K/NW 4000~4200K/WH 6000~6500K Input Voltage: AC85-265V 50/60Hz

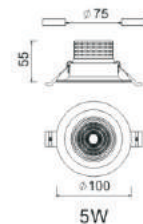



PRODUCT FEATURE

- Bridgelux COB chip from America
- TOP quality driver

| Model No. | SH61310 | SH61320 | SH61330 |
|-----------|-----------|-----------|-----------|
| Power | 10W | 20W | 30W |
| Lumen | 900lm | 1800lm | 2700lm |
| Material | Aluminum | Aluminum | Aluminum |
| Chip | Bridgelux | Bridgelux | Bridgelux |
| Pcs/Ctn | 50 | 25 | 10 |

WW 3000~3200K/NW 4000~4200K/WH 6000~6500K Input Voltage: AC85-265V 50/60Hz



Accessories

| | | |
|--|--------------------|-------|
| | black track line | 1m/2m |
| | white track line | 1m/2m |
| | "-" type connector | WH/BK |
| | "L" type connector | WH/BK |
| | "+" type connector | WH/BK |

PRODUCT FEATURE

- Bridgelux COB chip from America
- TOP quality driver

| Model No. | SH6515 | SH6530 | SH61530 | SH61630 |
|-----------|-----------|-----------|-----------|-----------------|
| Power | 15W | 30W | 30W | E27 MAX LED 30W |
| Lumen | 1350lm | 2700lm | 2700lm | / |
| Material | Aluminum | Aluminum | Aluminum | Aluminum |
| Chip | Bridgelux | Bridgelux | Bridgelux | / |
| Pcs/Ctn | 20 | 20 | 20 | 20 |

WW 3000~3200K/NW 4000~4200K/WH 6000~6500K Input Voltage: AC85-265V 50/60Hz

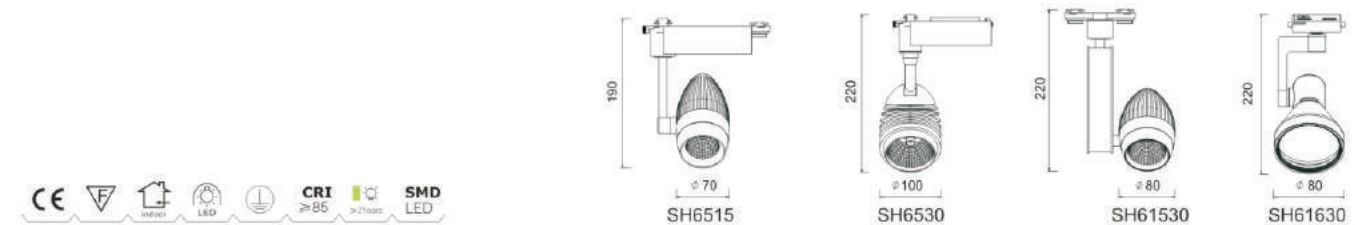



COLORFUL COB SPOT LIGHT



White+Black



White+Chrome



Champagne+Brown



Silver+Black



Pearl Silver+Chrome



Brush Chrome+Golden



Chrome+Golden



Chrome+Pearl French Golden



Pearl Silver+Golden



AB+HK Mirror.....

PRODUCT FEATURE

- Bridgelux COB chip from America
- TOP quality driver

| Model No. | SH23830R | SH-SQ-1 | SH-SQ-2 | SH-SQ-3 |
|-----------|-----------|----------|----------|----------|
| Power | 10W | / | / | / |
| Lumen | 850lm | / | / | / |
| Material | Aluminum | Aluminum | Aluminum | Aluminum |
| Chip | Bridgelux | / | / | / |
| Pcs/Ctn | 50 | 100 | 100 | 100 |

WW 3000~3200K/NW 4000~4200K/WH 6000~6500K Input Voltage: AC85-265V 50/60Hz

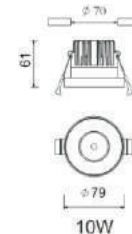

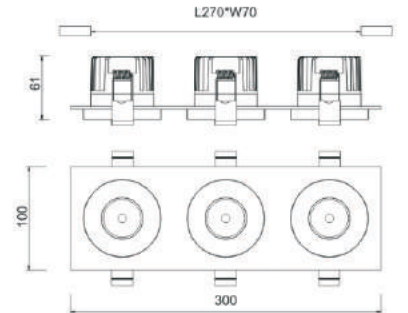
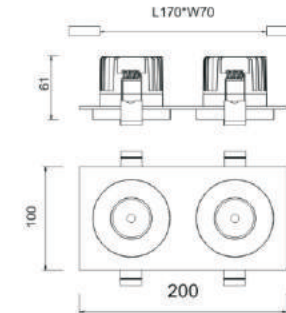
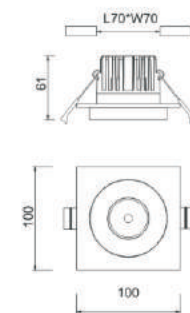
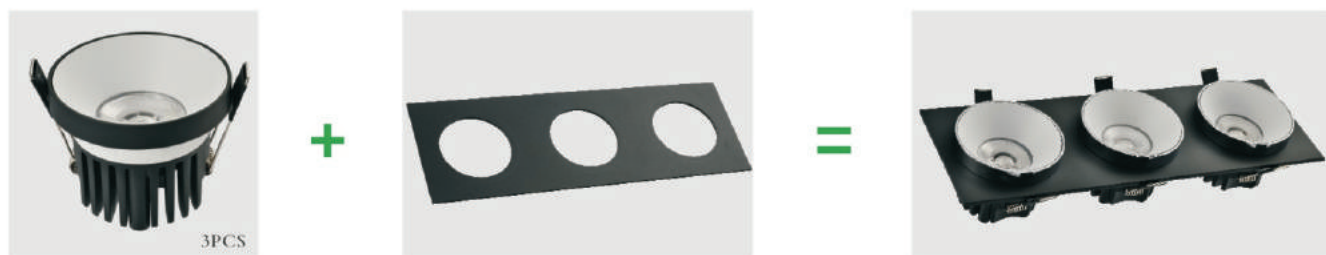
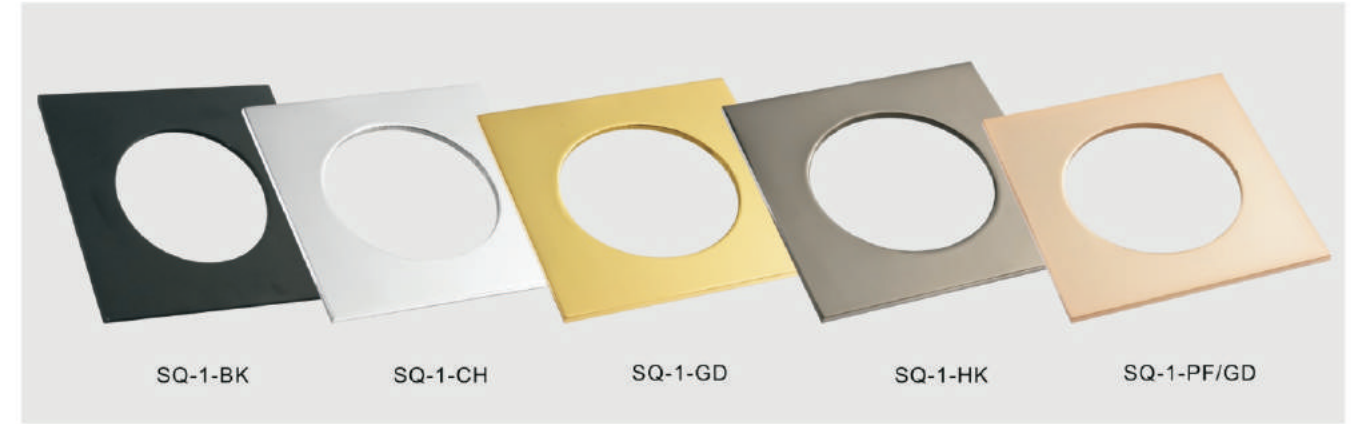



DELICATE
UNIQUE
SPOT LIGHT

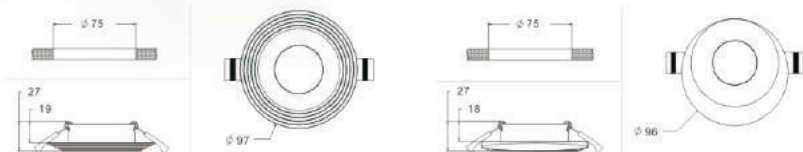

SHM001-WH



SHM002-WH



SHM001-GD

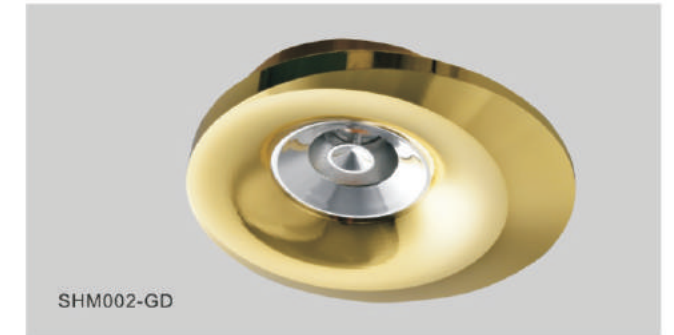

SHM002-GD



SHM001-CH



SHM002-CH



SHM001-HK



SHM002-HK

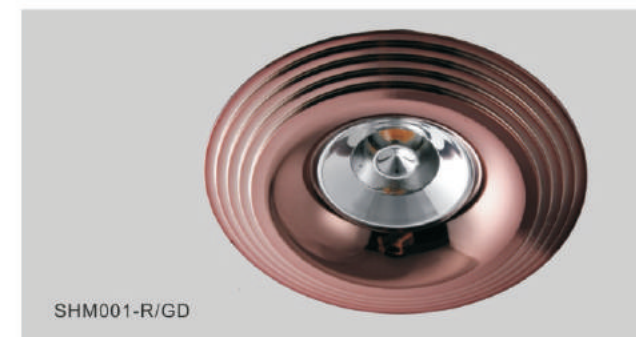

SHM001-R/GD

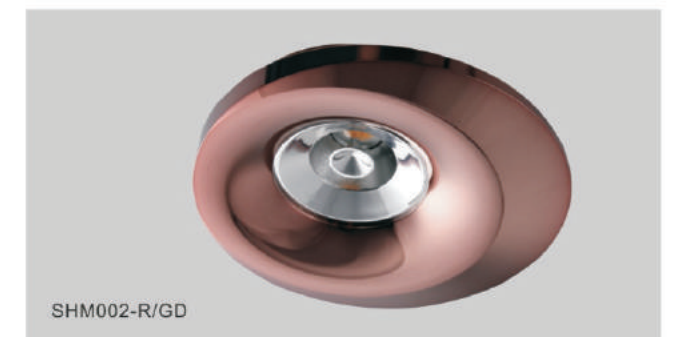

SHM002-R/GD

DELICATE
UNIQUE
SPOT LIGHT

Technical drawings showing dimensions: $\phi 75$, 20, 14, $\phi 98$.

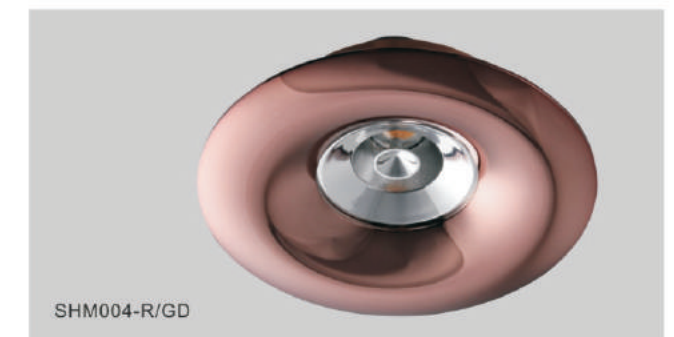
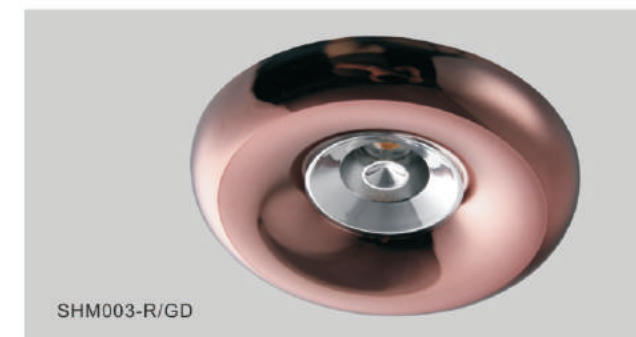
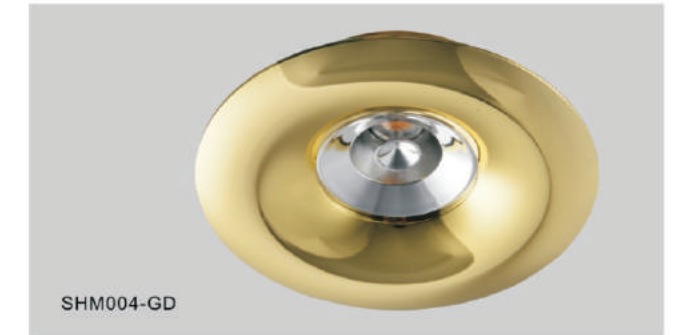

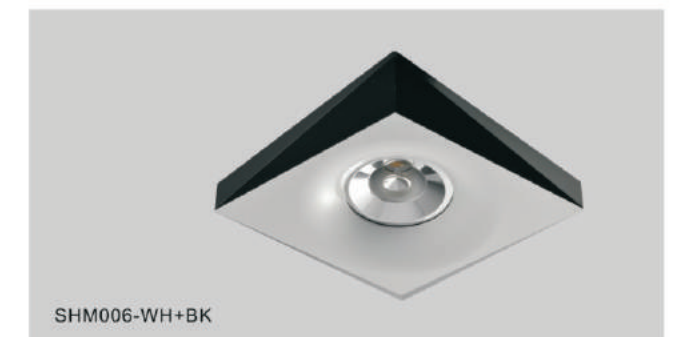
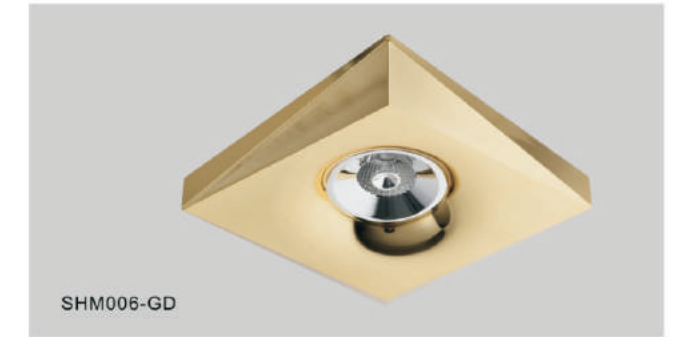



DELICATE
UNIQUE
SPOT LIGHT

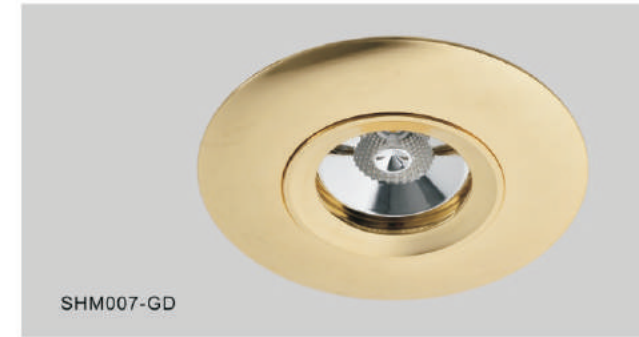

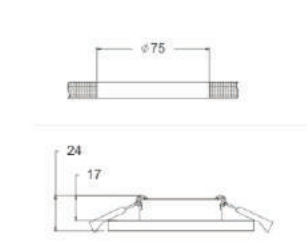
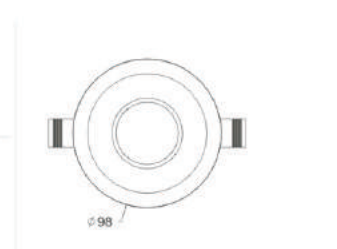
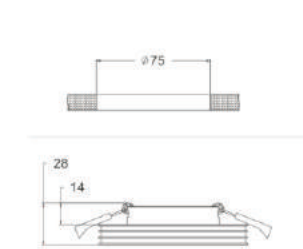
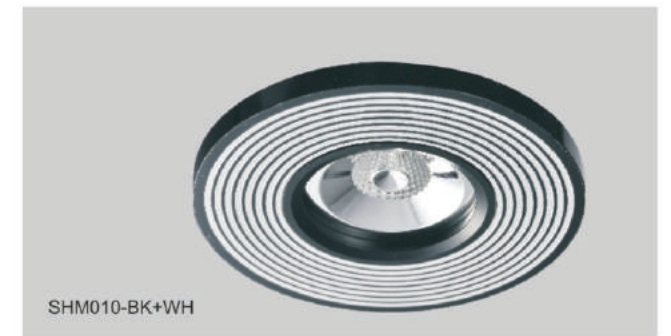
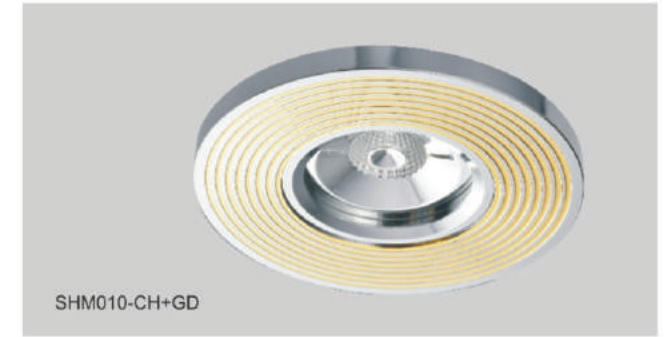
DELICATE UNIQUE
SPOT LIGHT



SHM017-WH



SHM017-HK



SHM017-GD



SHM017-CH



SHM017-CO/P

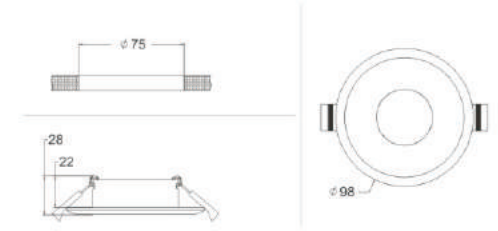

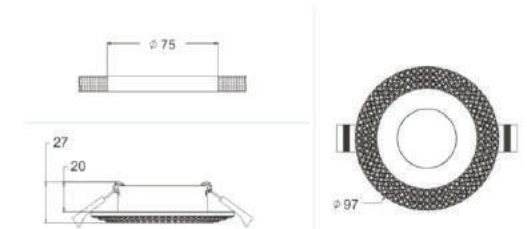
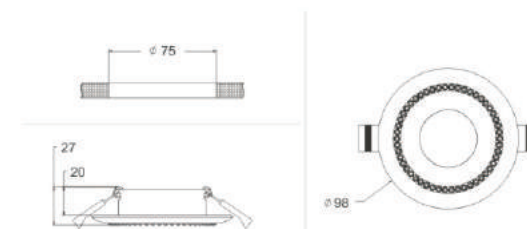
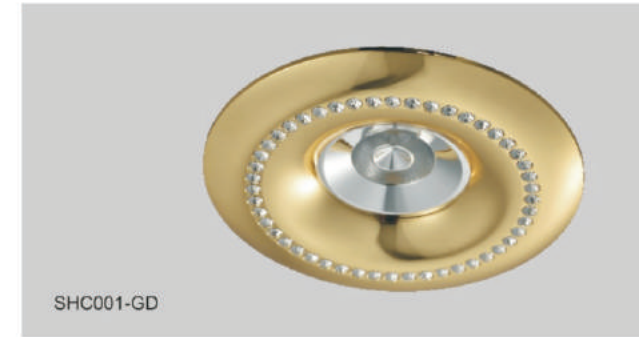

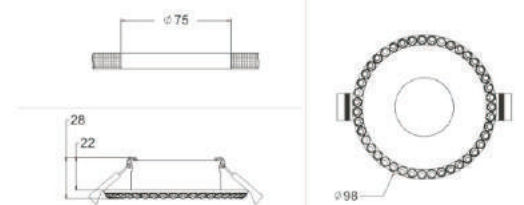
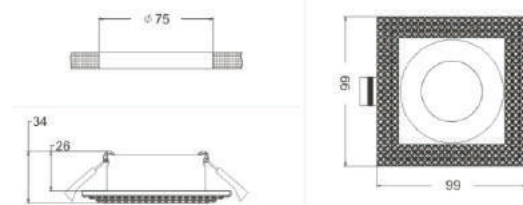
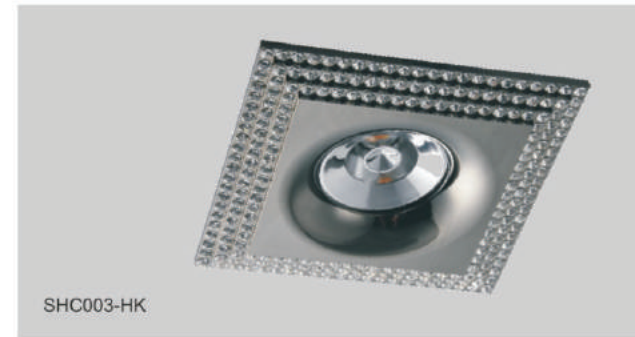
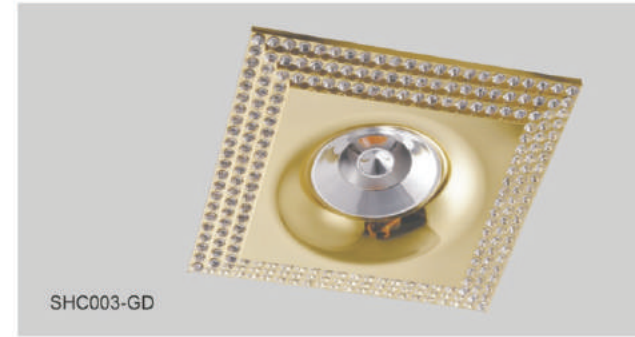
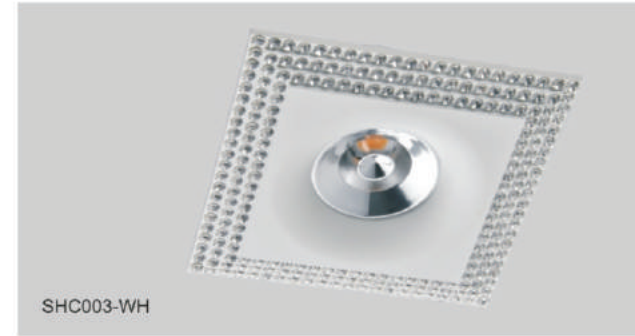
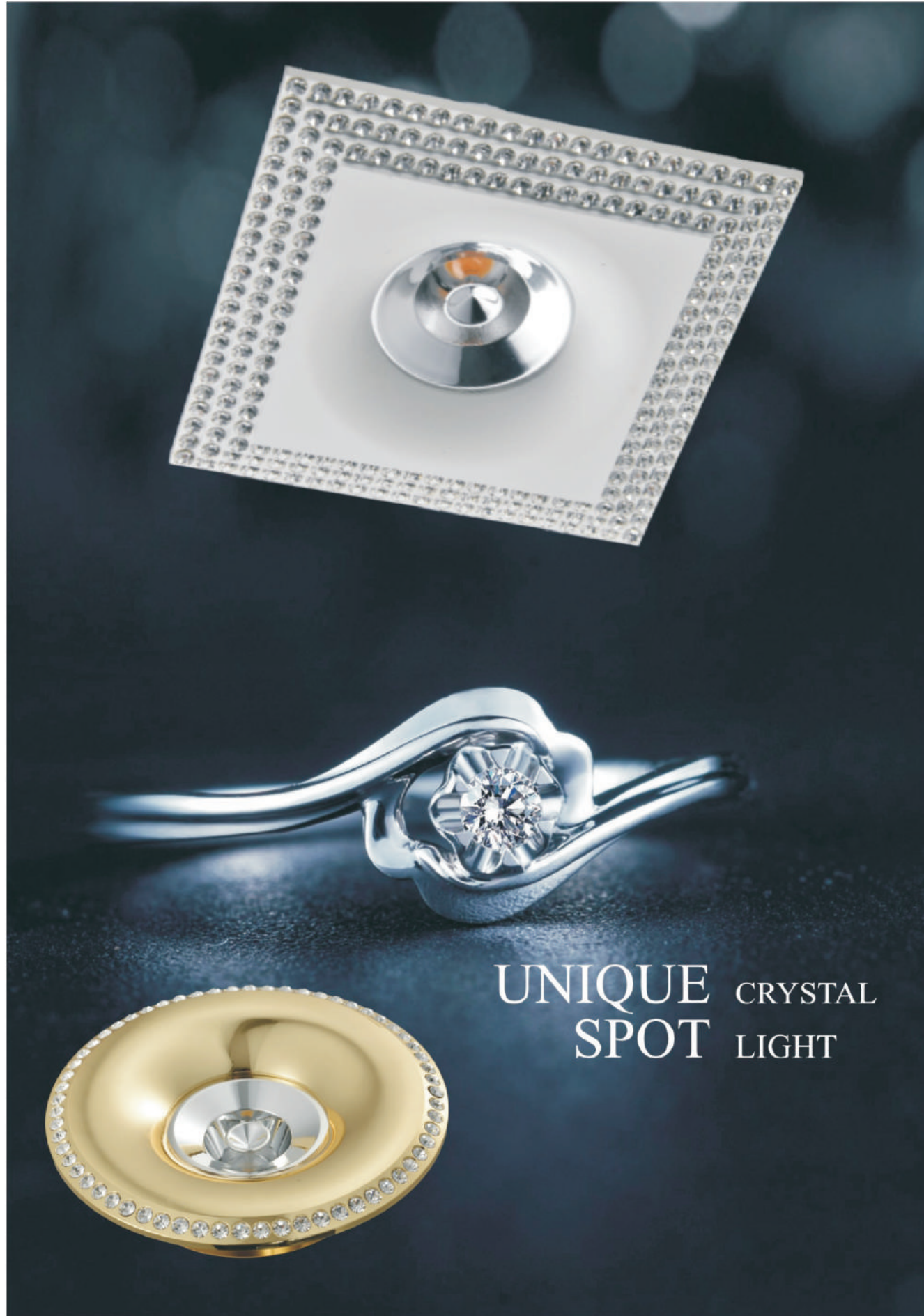



UNIQUE CRYSTAL
SPOT LIGHT



SHC005-WH



SHC006-WH



SHC005-GD



SHC006-GD



SHC005-CH



SHC006-CH



SHC005-HK



SHC006-HK

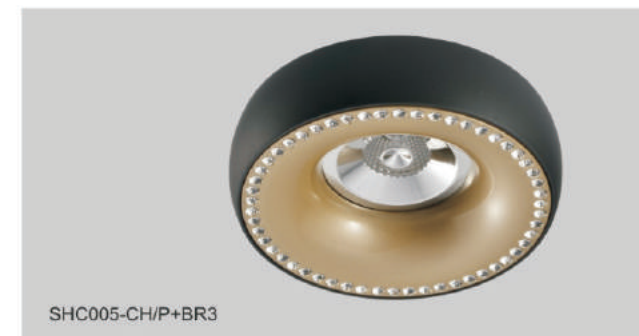

SHC005-CH/P+BR3

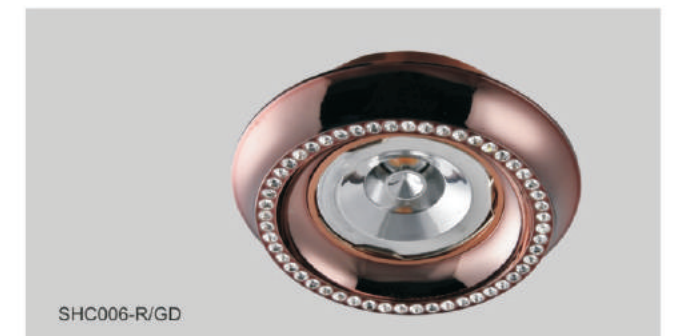

SHC006-R/GD

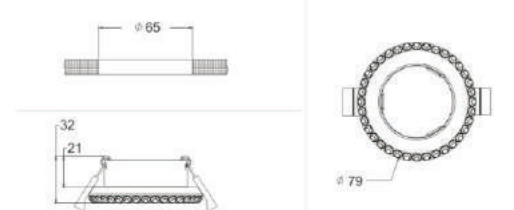
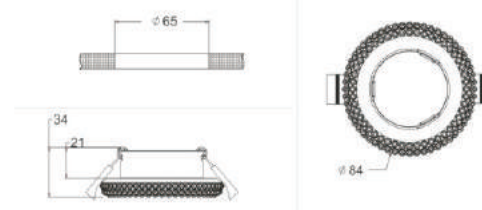

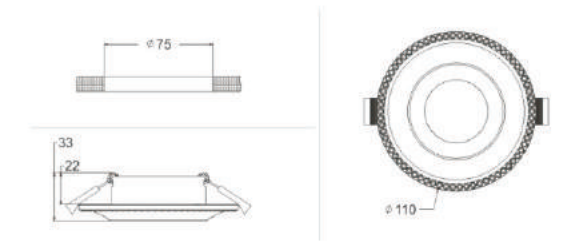
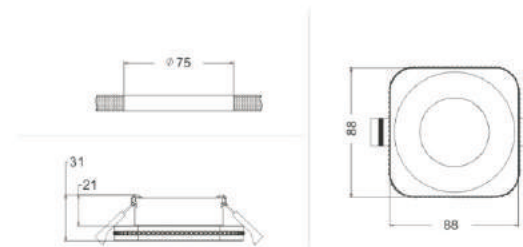
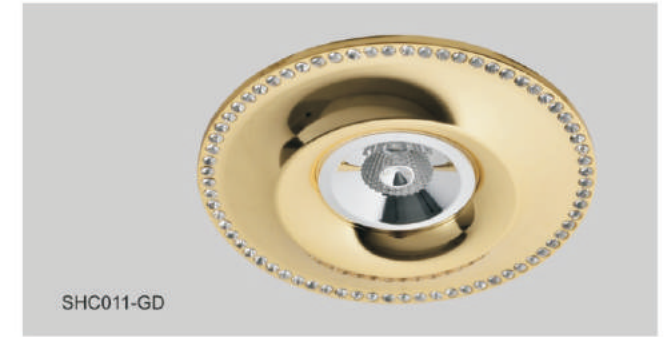



SH-B001-3W



SH-B001-5W



SH-B001-7W



SH-B002-3W



SH-B002-5W



SH-B002-7W



SH-B003-3W



SH-B003-5W



SH-B003-7W

| | | | |
|-----------|------------|------------|------------|
| Model No. | SH-B001-3W | SH-B001-5W | SH-B001-7W |
| Model No. | SH-B002-3W | SH-B002-5W | SH-B002-7W |
| Model No. | SH-B003-3W | SH-B003-5W | SH-B003-7W |
| Power | 3W | 5W | 7W |
| Lumen | 270lm | 450lm | 630lm |
| Material | aluminum | aluminum | aluminum |
| Chip | Bridgelux | Bridgelux | Bridgelux |
| Pcs/Ctn | 100 | 100 | 100 |

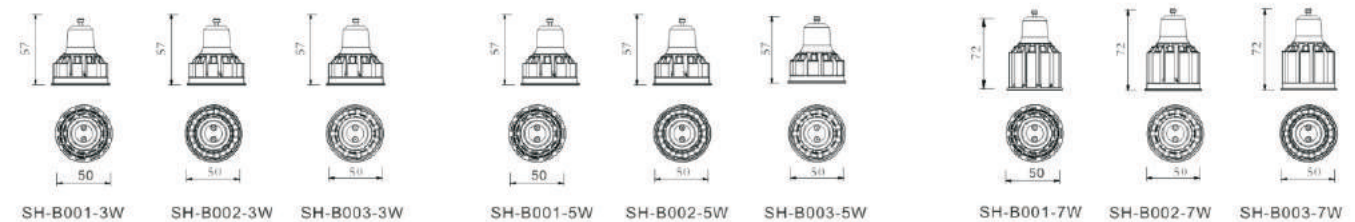

SH-B001-3W SH-B002-3W SH-B003-3W SH-B001-5W SH-B002-5W SH-B003-5W SH-B001-7W SH-B002-7W SH-B003-7W



SHT8F518/SHT8F409



SHG9105

| | | | |
|-----------|----------|----------|---------|
| Model No. | SHT8F518 | SHT8F409 | SHG9105 |
| Power | 9W | 18W | 5W |
| Base | / | / | G9 |
| Lumen | 600lm | 1200lm | 450lm |
| Material | Plastic | Plastic | Plastic |
| Chip | EDISON | EDISON | EDISON |
| Pcs/Ctn | 50 | 50 | 100 |

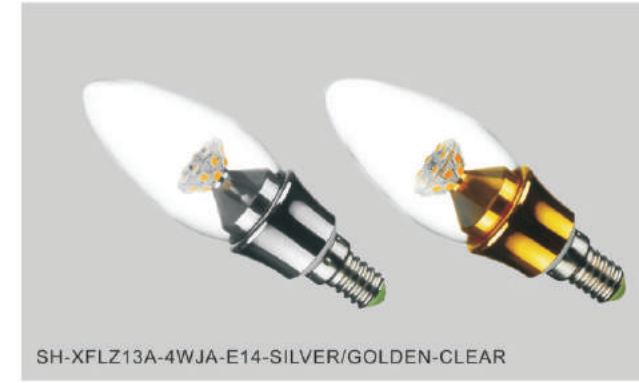

SH-XFLZ13A-4WJA-E14-SILVER/GOLDEN-CLEAR

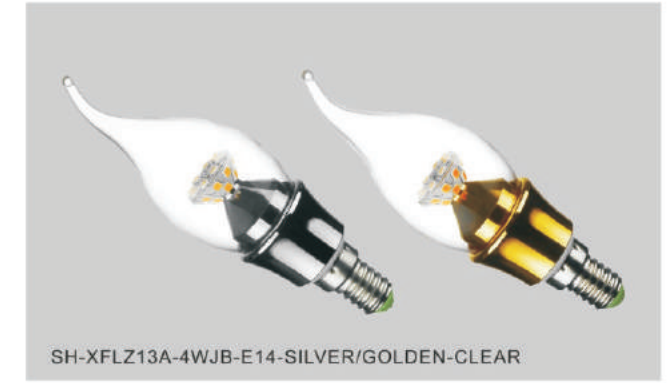

SH-XFLZ13A-4WJB-E14-SILVER/GOLDEN-CLEAR

| | | | | |
|-----------|---------------------|---------------------|---------------------|---------------------|
| Model No. | SH-XFLZ13A-4WJA-E14 | SH-XFLZ13A-4WYA-E14 | SH-XFLZ13A-4WJB-E14 | SH-XFLZ13A-4WYB-E14 |
| Power | 4W | 4W | 4W | 4W |
| Lumen | 310lm | 310lm | 310lm | 310lm |
| Chip | San'an | San'an | San'an | San'an |
| Pcs/Ctn | 100 | 100 | 100 | 100 |



SH-LNZX-106AJ-E27-CHROME/GOLDEN-CLEAR



SH-LNZX-106AY-E27-CHROME/GOLDEN-FROSTED



SH-LNZX-106AJ-E14-CHROME/GOLDEN-CLEAR



SH-LNZX-106AY-E14-CHROME/GOLDEN-FROSTED

| | | | | |
|-----------|-------------------|-------------------|-------------------|-------------------|
| Model No. | SH-LNZX-106AJ-E27 | SH-LNZX-106AY-E27 | SH-LNZX-106AJ-E14 | SH-LNZX-106AY-E14 |
| Power | 6W | 6W | 6W | 6W |
| Lumen | 480lm | 480lm | 480lm | 480lm |
| Chip | San'an | San'an | San'an | San'an |
| Pcs/Ctn | 50 | 50 | 50 | 50 |



SH-XFQP01-4WY-E27-SILVER/GOLDEN



SH-XFLZ19-5WYQ-E28-SILVER/GOLDEN



SH-XFDS-5WQ-E27



SH-XFDS-4WB-E14



SH-XFLZ22C-4WJ-E14-SILVER/GOLDEN-CLEAR



SH-XFCOB-6W/10WQP-E27-FROSTED

| | | | | | | |
|-----------|-------------------|--------------------|-----------------|-----------------|--------------------|-----------------------|
| Model No. | SH-XFQP01-4WY-E27 | SH-XFLZ19-5WYQ-E28 | SH-XFDS-5WQ-E27 | SH-XFDS-4WB-E14 | SH-XFLZ22C-4WJ-E14 | SH-XFCOB-6W/10WQP-E27 |
| Power | 4W | 4W | 4W | 4W | 6W | 6W/10W |
| Lumen | 380lm | 330lm | 800lm | 470lm | 720lm | 720lm/1200lm |
| Chip | San'an | San'an | San'an | San'an | San'an | San'an |
| Pcs/Ctn | 100 | 100 | 100 | 100 | 100 | 100 |